











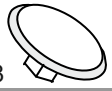

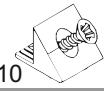

- | | | | | | | |
|---|---|---|--|--|--|--|
| x 12
4x16

H | x 4

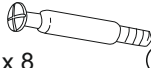
D | x 8

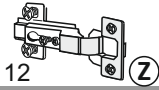
F | x 8

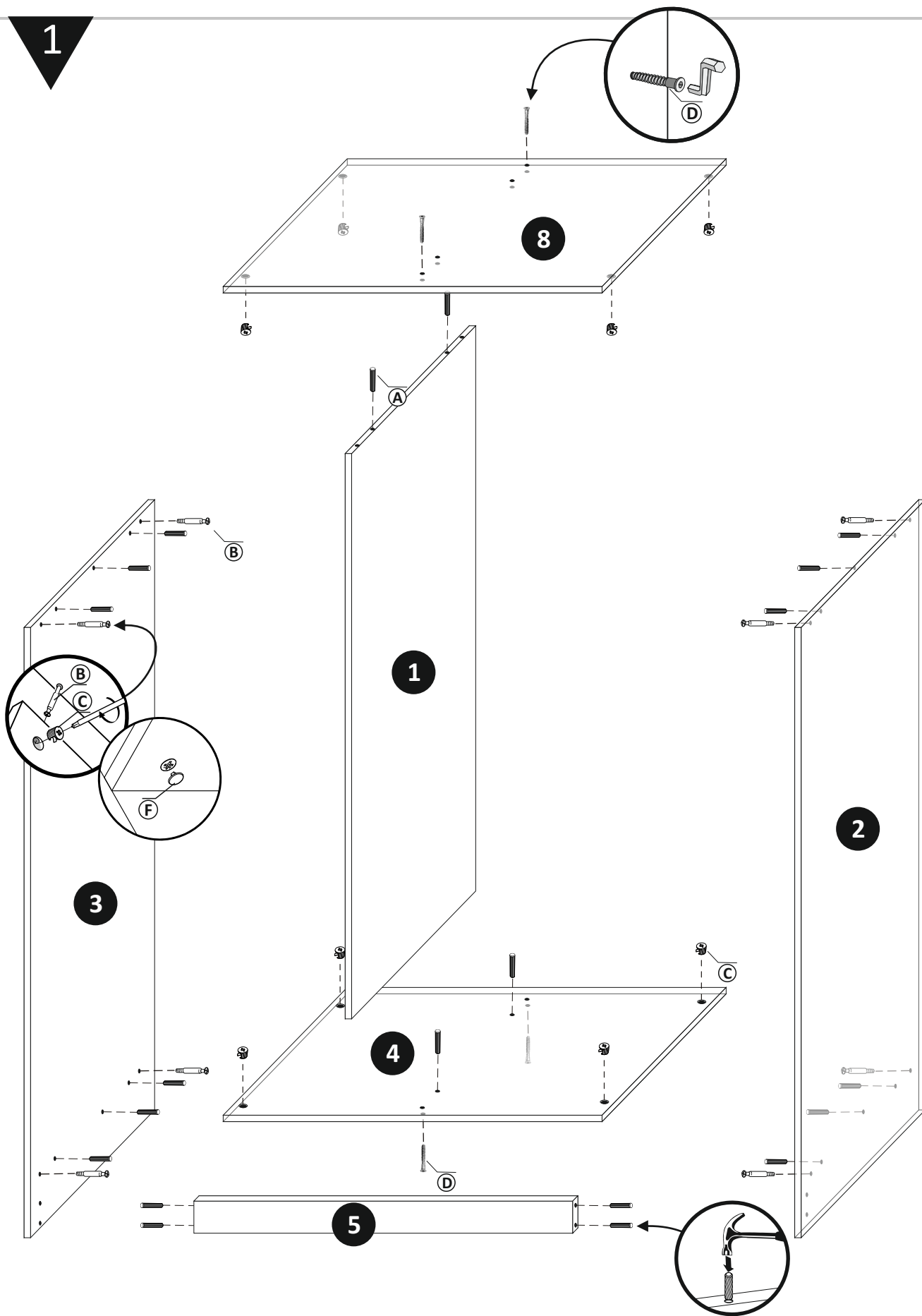
C | x 10

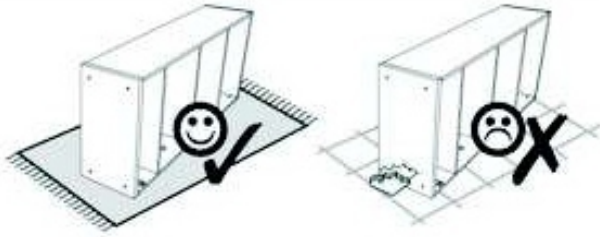
M | 4x30
x 6

A | x 2

L |
| x 28

R | x 12

J | x 12

I | x 8

B | x 12

E | x 12

Z | x 1

G |

EDEN 1/3 - WARDROBE THREE DOORS 2/6



1





2

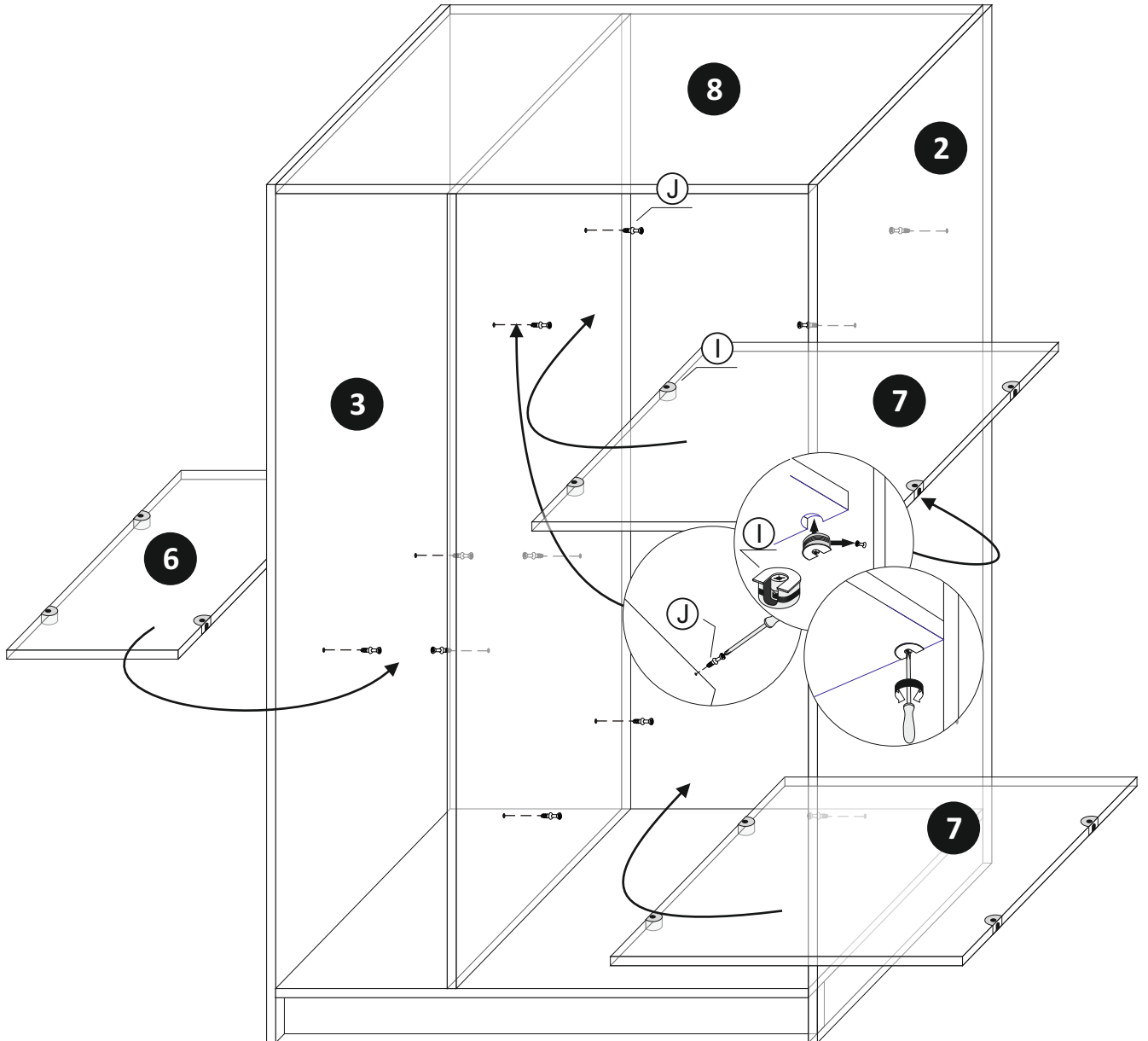

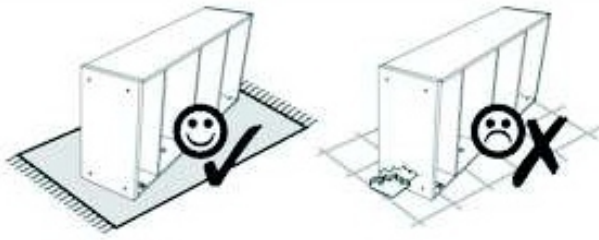

3

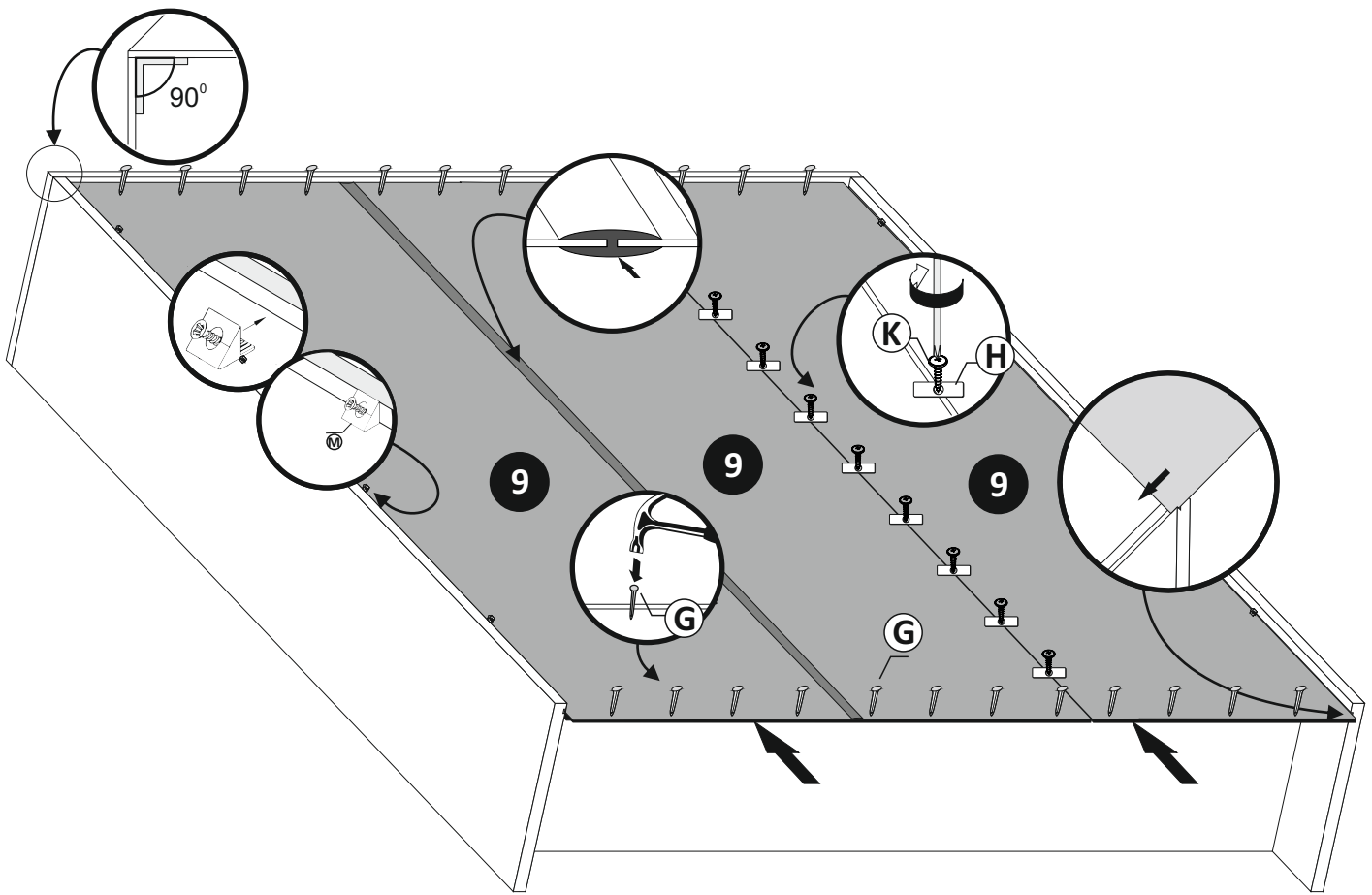

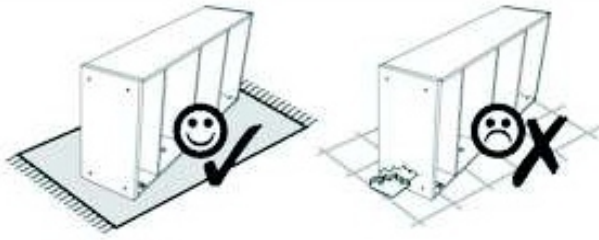

4

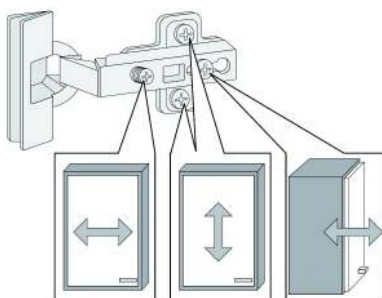
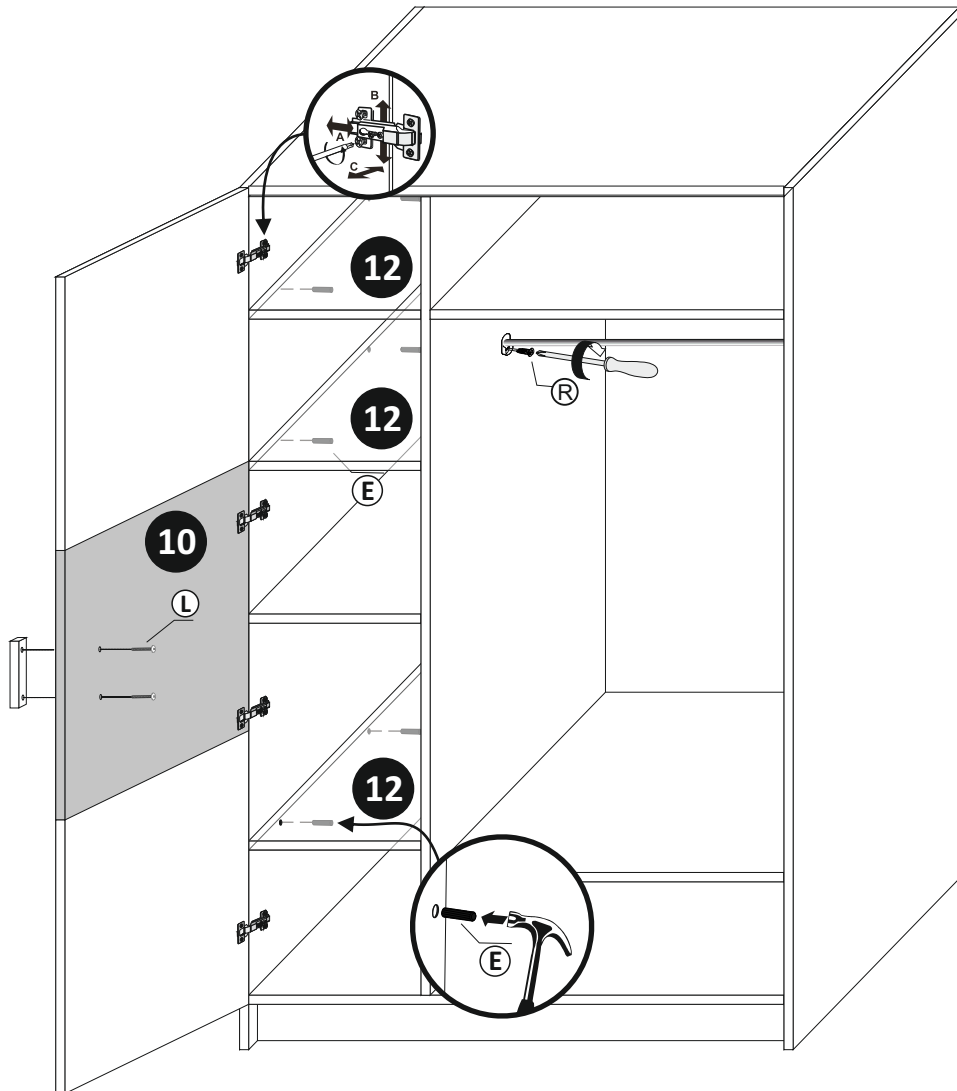

Türen einstellen (Scharniere justieren)
 Adjusting the doors (adjusting the hinges)
Deuren instellen (scharnieren afstellen)
 Nastawić drzwi (wyrównać zawiasy)
Капıларın аярланması (ментешелерın seviye аярı)
 Регулировка дверей (регулировка шарнира)

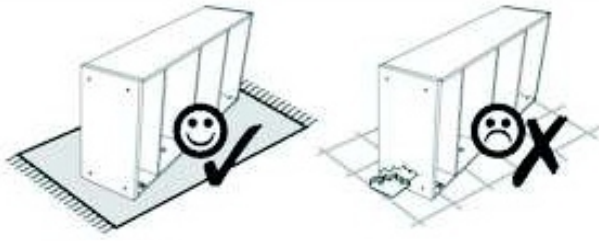

5

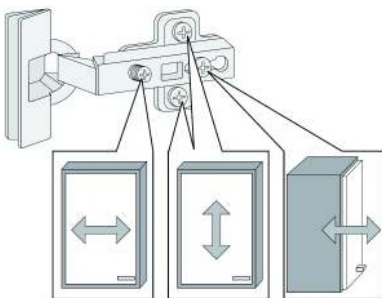
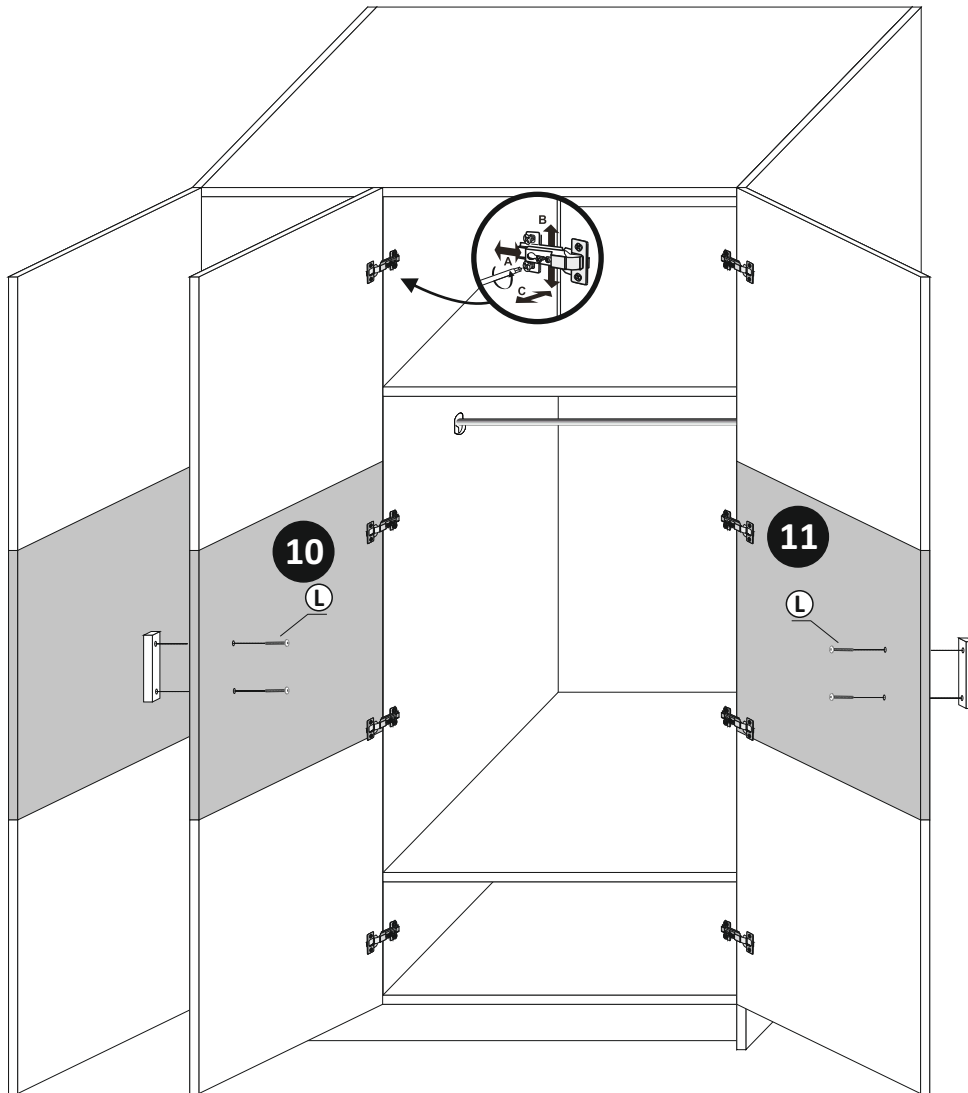

Türen einstellen (Scharniere justieren)
Adjusting the doors (adjusting the hinges)
Deuren instellen (scharnieren afstellen)
Nastawić drzwi (wyrównać zawiasy)
Капірларын аяланması (ментешелерин seviye аяarı)
Регулировка дверей (регулировка шарнира)