











- |     |   |              |   |      |   |   |      |  |  |      |   |   |      |   |   |     |
|-----|---|--------------|---|------|---|---|------|--|--|------|---|---|------|---|---|-----|
| x 2 |  | 4x16<br>x 16 |  | (X)  | 0,9x5<br>x 24   |  | (R)  | x 9  |  | (M)  | x 48  |  | (A)  | x 35  |  | (G) |
| x 6 |  | 4x30         | (L)   | x 12 |  | (F)   | x 12 |  | (B)  | x 12 |  | (C)   | x 12 |  | (K)   |     |

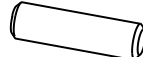

1

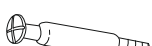

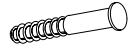
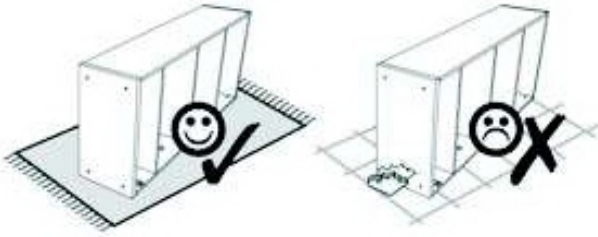
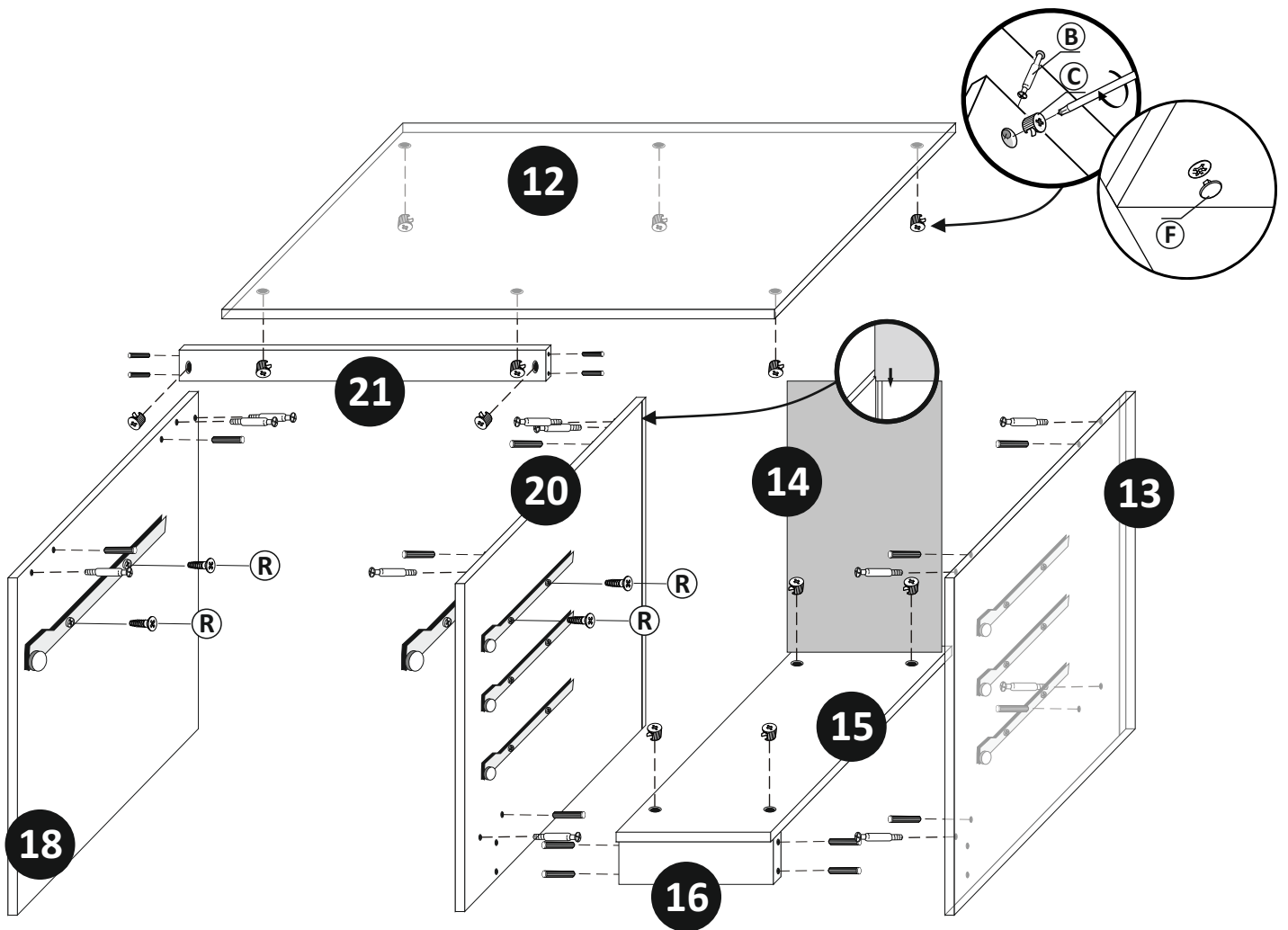
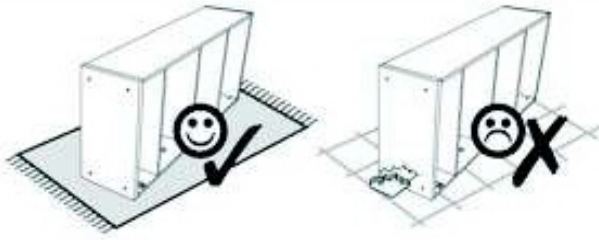

2

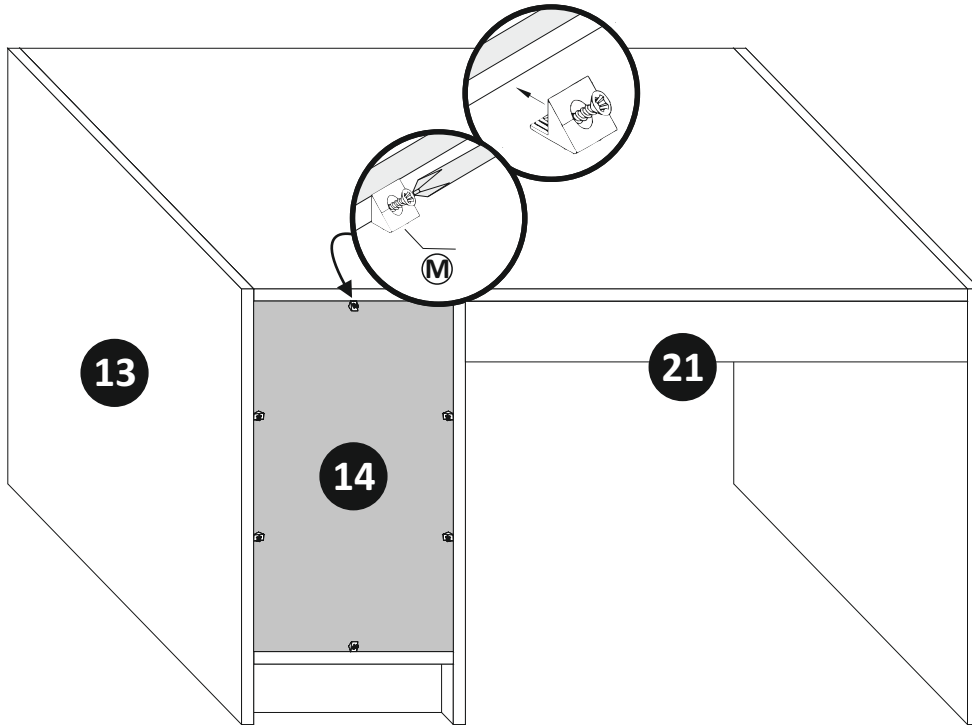

3

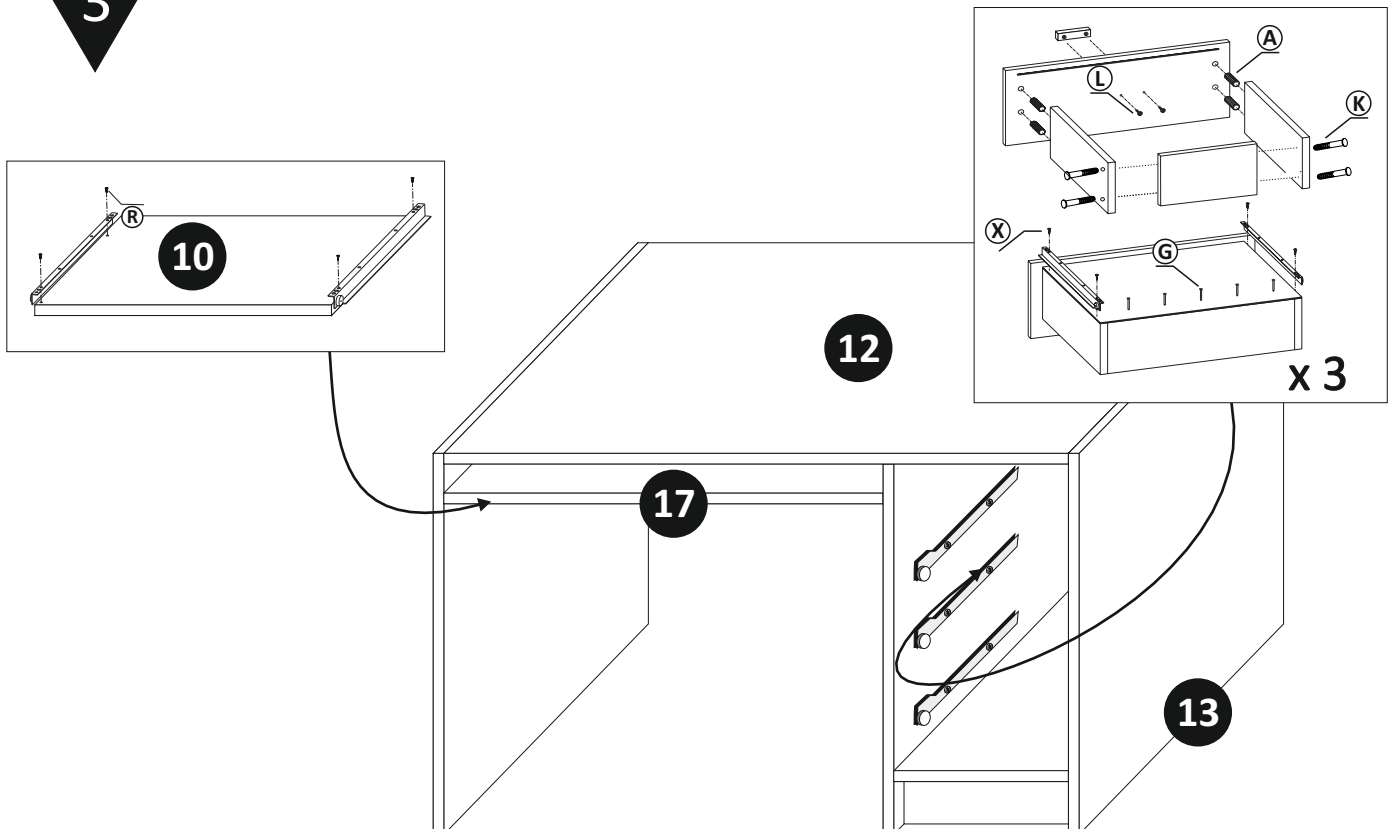

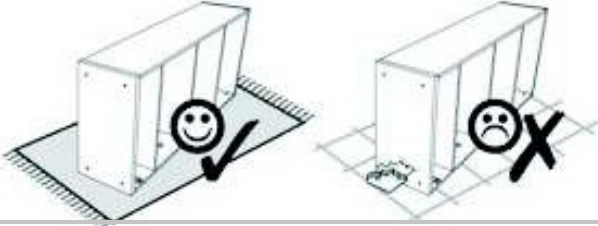

4

