

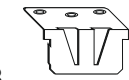

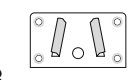

- | | | | |
|-------------------------------------------------------------------------------------------------------------------------|----------------------------------------------------------------------------------------------------------------|------------------------------------------------------------------------------------------------------------------|------------------------------------------------------------------------------------------------------------------|
| <p>4x20
x 2</p>  <p>R</p> | <p>x 8</p>  <p>X</p> | <p>x 8</p>  <p>E</p> | <p>x 8</p>  <p>A</p> |
| <p>x 56</p>  <p>D</p> | <p>x 8</p>  <p>E</p> | <p>x 8</p>  <p>D</p> | <p>x 8</p>  <p>D</p> |

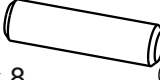

1



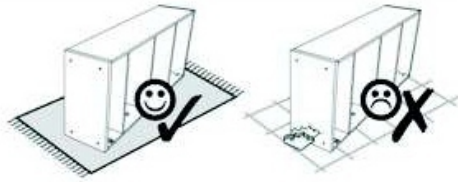
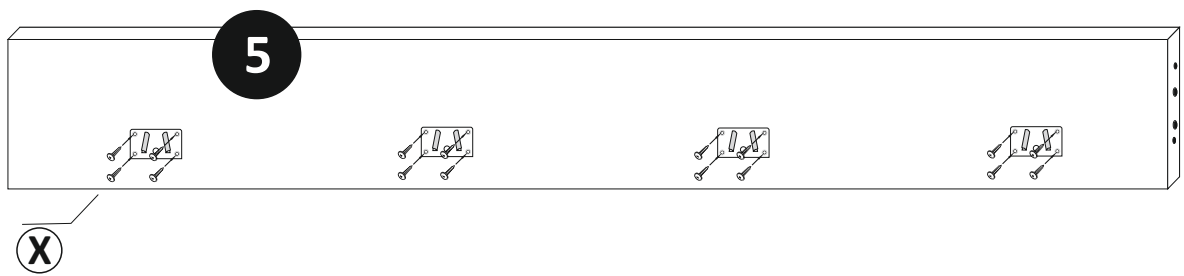
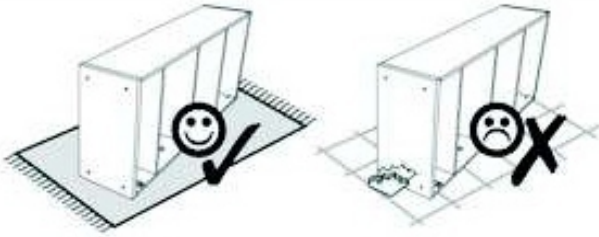

3

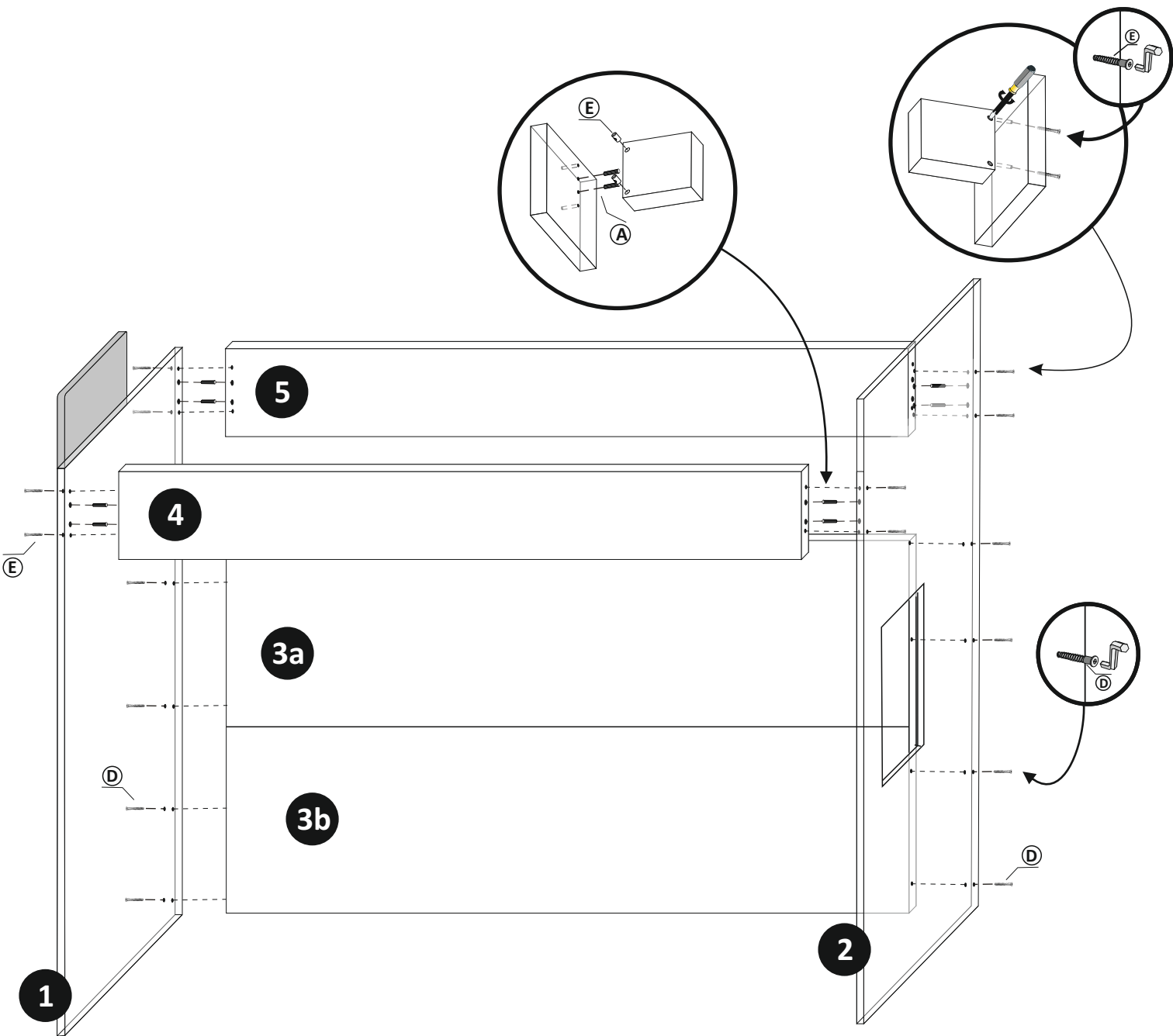

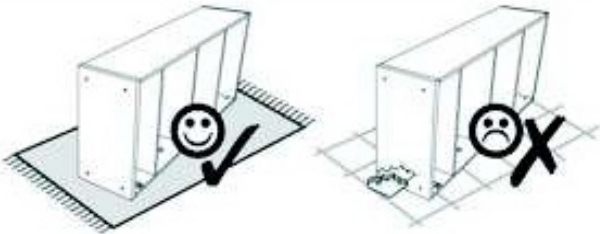

4

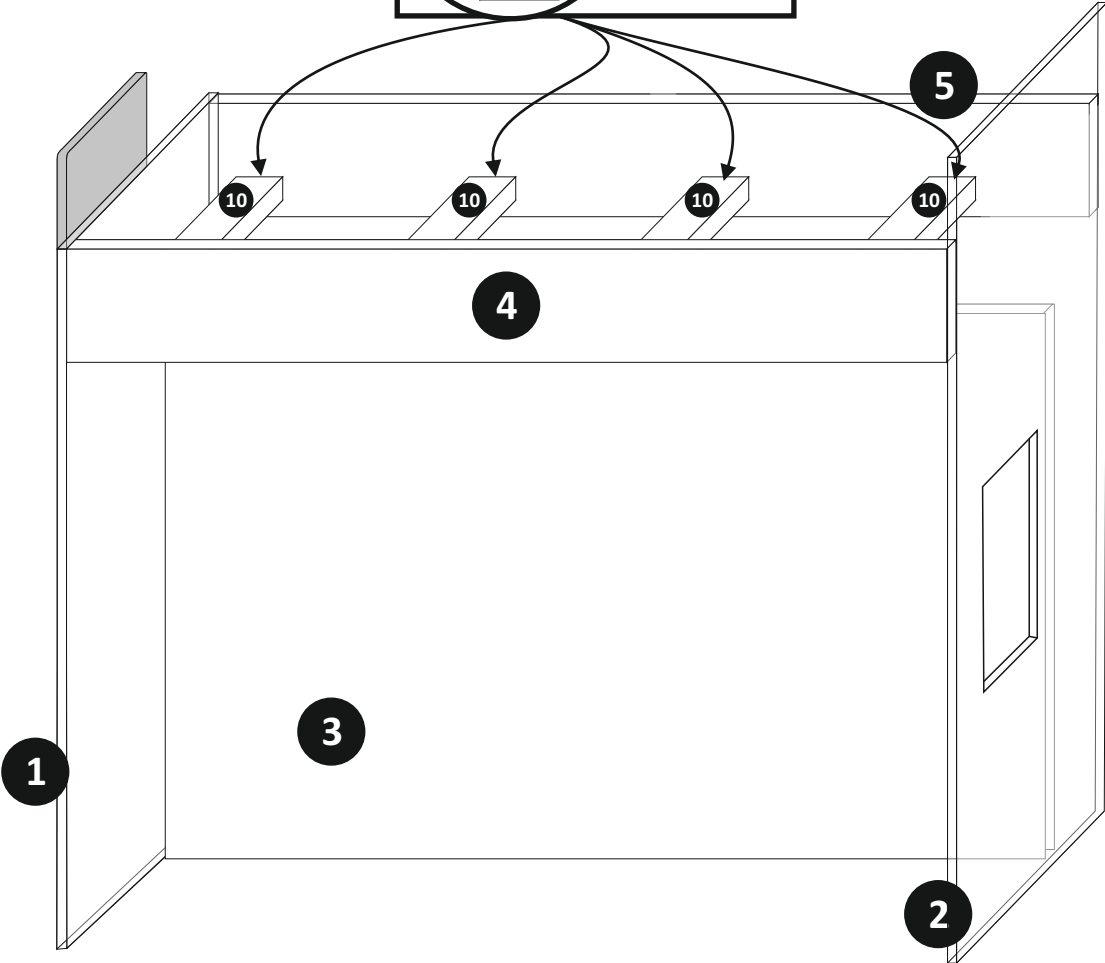
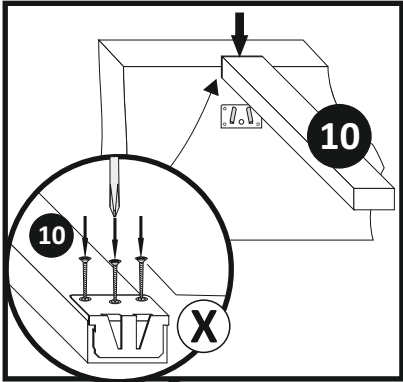

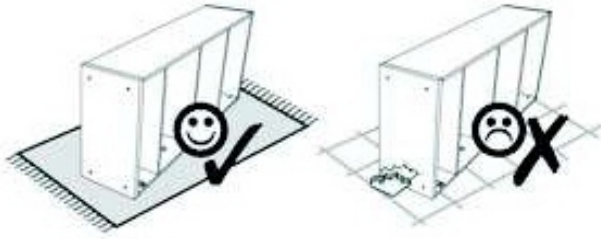

5

